

GAMING CHAIR MOD. YAR-9863N  
**CADIRA 1150**

**MANUAL**  
**DE USUARIO**  
USER'S MANUAL

# ESPECIFICACIONES

## SPECIFICATIONS



### GAMING CHAIR MOD. YAR-9863N

# CADIRA 1150

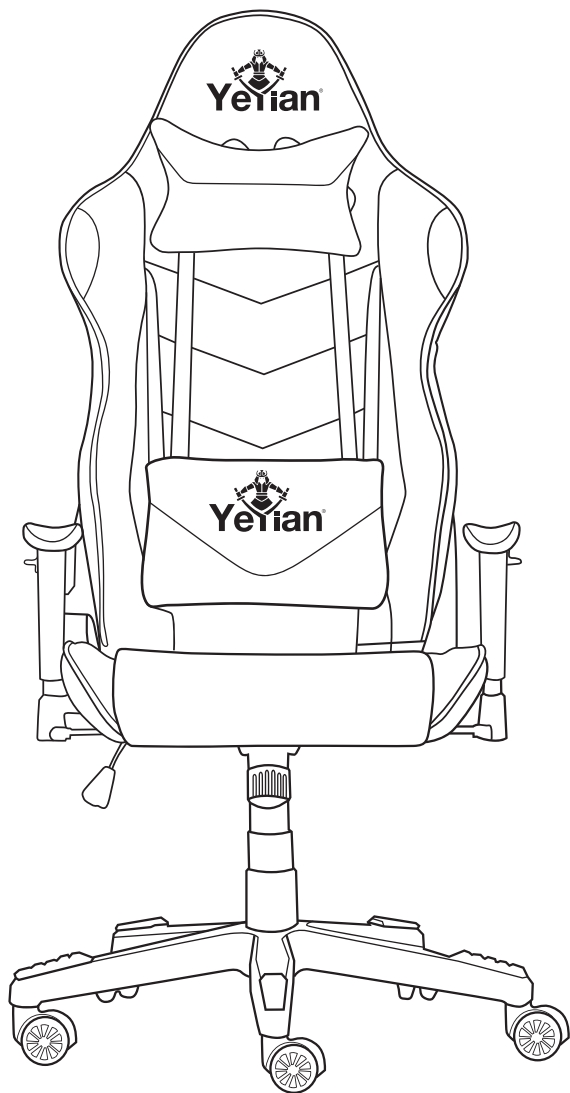

#### ESPECIFICACIONES / SPECIFICATIONS

Tamaño del Producto Product Size	1350 mm * 540 mm * 675 mm (Tamaño de Silla) 53.15 in * 21.26 in * 26.57 in (Chair Size) 870 mm * 650 mm * 310 mm (Tamaño de Embalaje) 34.25 in * 25.60 in * 12.20 in (Packaging Size)
Material del Producto Product Material	Poliuretano, Armazón Metálico de 1.5 mm, Nylon Polyurethane, 1.5 mm Metal Frame, Nylon
Adicionales Additional	Descansabrazos / Cojín Lumbar / Descanza Cabeza Armrest / Lumbar Cushion / Head Rest
Diseño Design	Ergonómico Ergonomic
Mecanismo Mechanism	Mariposa Butterfly
Piston Piston	Gas Clase 4 Class 4 Gas
Capacidad de Peso Weight Capacity	Soporta hasta 150 kg Supports up to 330 lbs
Peso Weight	19 kg 41.88 lbs

# PIEZAS

## PIECES



**A**  
1 PIEZA  
1 PIECE



**B**  
1 PIEZA  
1 PIECE

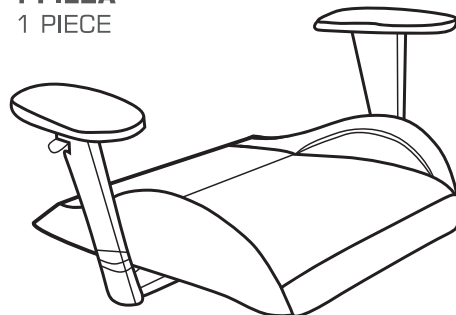

**C**  
1 PIEZA  
1 PIECE

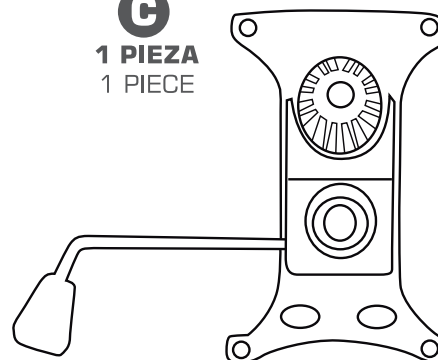

**D**  
1 PIEZA  
1 PIECE



**E**  
1 PIEZA  
1 PIECE

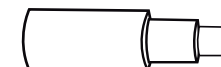

**F**  
1 PIEZA  
1 PIECE

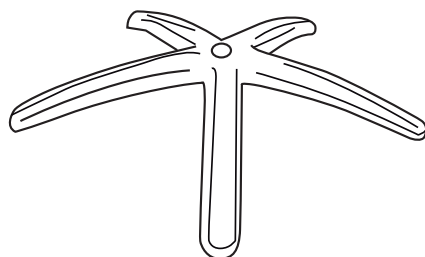

**G**  
5 PIEZAS  
5 PIECES

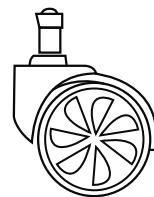

**H**  
4 PIEZAS  
4 PIECES



**Para Atornillar la Base Mecánica del Asiento a la Silla**  
To Screw the Mechanical Base of the Seat to the Chair

**I**  
10 PIEZAS  
10 PIECES



**J**  
2 PIEZAS  
2 PIECES

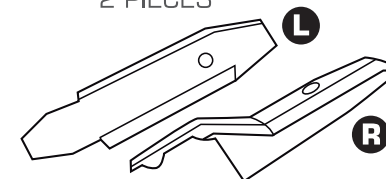

**K**  
2 PIEZAS  
2 PIECES



M5x8mm

**L**  
14 PIEZAS  
14 PIECES



**M**  
14 PIEZAS  
14PIECES



**N**  
1 PIEZA  
1 PIECE



**O**  
4 PIEZAS  
4 PIECES



**P**  
1 PIEZA  
1 PIECE



**Q**  
1 PIEZA  
1 PIECE



# INSTALACIÓN

INSTALLATION

